

INSTALLATION

WELD IN
• BOLT IN
• STANDARD CLAMP IN
• CONCEALED CLAMP IN

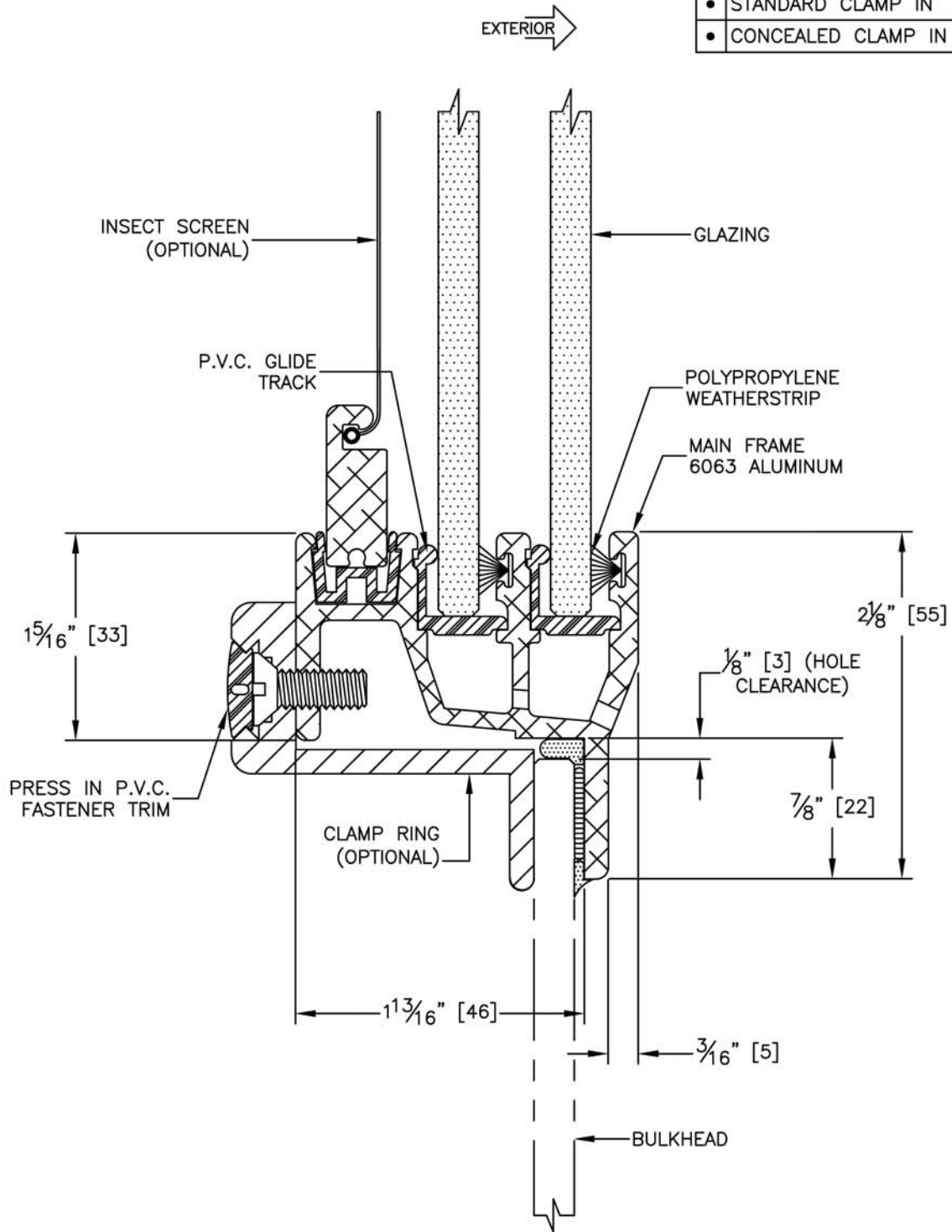

GLAZING THICKNESS TO BE 1/4" [6mm].
 STANDARD PLATE CUT RADIUS IS 3 1/8" [79mm], 3 5/8" [92mm], AND 4 1/8" [105mm].

	TITLE:	MODEL NO.	REV
	HORIZONTAL SLIDING WINDOW	WIN-1066-HS	—
	SCALE: N/A	SHEET: 1 OF: 1	

Clamp In Sliding Window with 1/4" Glazing

HORIZONTAL SLIDING WINDOW



PACIFIC COAST MARINE
 8000 23RD DRIVE WEST, EVERETT, WASHINGTON, USA 98203
 PHONE: +1.425.743.9550 WWW.PCMII.COM